

FOU 30 / ML6



Operating Instructions

Oscillation unit

Safety rules

DANGER!



“**DANGER!**” indicates an imminently hazardous situation which, if not avoided, will result in death or serious injury. This signal word is to be limited to the most extreme situations. This signal word is not used for property damage hazards unless personal injury risk appropriate to this level is also involved.

WARNING!



“**WARNING!**” indicates a potentially hazardous situation which, if not avoided, could result in death or serious injury. This signal word is not used for property damage hazards unless personal injury risk appropriate to this level is also involved.

CAUTION!



“**CAUTION!**” indicates a potentially hazardous situation which, if not avoided, may result in minor or moderate injury. It may also be used to alert against unsafe practices that may cause property damage.

NOTE!



“**NOTE!**” indicates a situation which implies a risk of impaired welding result and damage to the equipment.

Important!

“**Important!**” indicates practical hints and other useful special-information. It is no signal word for a harmful or dangerous situation.

Whenever you see any of the symbols shown above, you must pay even closer attention to the contents of the manual!

General remarks



This equipment has been made in accordance with the state of the art and all recognised safety rules. Nevertheless, incorrect operation or misuse may still lead to danger for

- the life and well-being of the operator or of third parties,
- the equipment and other tangible assets belonging to the owner/operator,
- efficient working with the equipment.

All persons involved in any way with starting up, operating, servicing and maintaining the equipment must

- be suitably qualified
- know about welding and
- read and follow exactly the instructions given in this manual.

The instruction manual must be kept at the machine location at all times. In addition to the instruction manual, copies of both the generally applicable and the local accident prevention and environmental protection rules must be kept on hand, and of course observed in practice.

All the safety instructions and danger warnings on the machine itself:

- must be kept in a legible condition
- must not be damaged, must not be removed
- must not be covered, pasted or painted over

For information about where the safety instructions and danger warnings are located on the machine, please see the section of your machine’s instruction manual headed “General remarks”.

General remarks
(continued)

Any malfunctions which might impair machine safety must be eliminated immediately - meaning before the equipment is next switched on.

It's your safety that's at stake!

Utilisation for intended purpose only



The machine may only be used for jobs as defined by the "Intended purpose".

The machine may ONLY be used for the welding processes stated on the rating plate.

Utilisation for any other purpose, or in any other manner, shall be deemed to be "not in accordance with the intended purpose". The manufacturer shall not be liable for any damage resulting from such improper use.

Utilisation in accordance with the "intended purpose" also comprises

- complete reading and following of all the instructions given in this manual
- complete reading and following of all the safety instructions and danger warnings
- performing all stipulated inspection and servicing work.

The appliance must never be used for the following:

- Thawing pipes
- Charging batteries/accumulators
- Starting engines

The machine is designed to be used in industrial and workshop environments. The manufacturer shall not be liable for any damage resulting from use of the machine in residential premises.

likewise the manufacturer will accept no liability for defective or faulty work results.

Ambient conditions



Operation or storage of the power source outside the stipulated range is deemed to be "not in accordance with the intended use". The manufacturer shall not be liable for any damage resulting herefrom.

Temperature range of ambient air:

- when operating: - 10 °C to + 40 °C (14 °F to 104 °F)
- when being transported or stored: - 25 °C to + 55 °C (-13 °F to 131 °F)

Relative atmospheric humidity:

- up to 50 % at 40 °C (104 °F)
- up to 90 % at 20 °C (68 °F)

Ambient air: Free of dust, acids, corrosive gases or substances etc.

Elevation above sea level: Up to 2000 m (6500 ft)

Obligations of owner/operator



The owner/operator undertakes to ensure that the only persons allowed to work with the machine are persons who

- are familiar with the basic regulations on workplace safety and accident prevention and who have been instructed in how to operate the machine
- have read and understood the sections on "safety rules" and the "warnings" contained in this manual, and have confirmed as much with their signatures
- be trained in such a way that meets with the requirements of the work results

Regular checks must be performed to ensure that personnel are still working in a safety-conscious manner.

Obligations of personnel



- Before starting work, all persons to be entrusted with carrying out work with (or on) the machine shall undertake
- to observe the basic regulations on workplace safety and accident prevention
 - to read the sections on “safety rules” and the “warnings” contained in this manual, and to sign to confirm that they have understood these and will comply with them.

Before leaving the workplace, personnel must ensure that there is no risk of injury or damage being caused during their absence.

Mains connection

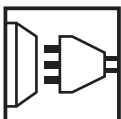

High-performance devices can affect the quality of the mains power due to their current-input.

This may affect a number of types of device in terms of:

- connection restrictions
- criteria with regard to maximum permissible mains impedance ^{*)}
- criteria with regard to minimum short-circuit power requirement ^{*)}

^{*)} at the interface with the public mains network

see Technical Data

In this case, the plant operator or the person using the device should check whether or not the device is allowed to be connected, where appropriate through discussion with the power supply company.

Protection for yourself and other persons



- When welding, you are exposed to many different hazards such as:
- flying sparks and hot metal particles
 - arc radiation which could damage your eyes and skin



- harmful electromagnetic fields which may put the lives of cardiac pace-maker users at risk



- electrical hazards from mains and welding current



- increased exposure to noise



- noxious welding fumes and gases.

Anybody working on the workpiece during welding must wear suitable protective clothing with the following characteristics:

- flame-retardant
- isolating and dry
- must cover whole body, be undamaged and in good condition
- protective helmet
- trousers with no turn-ups



Protection for yourself and other persons (continued)



“Protective clothing” also includes:

- protecting your eyes and face from UV rays, heat and flying sparks with an appropriate safety shield containing appropriate regulation filter glass
- wearing a pair of appropriate regulation goggles (with sideguards) behind the safety shield
- wearing stout footwear that will also insulate even in wet conditions
- protecting your hands by wearing appropriate gloves (electrically insulating, heat-proof)
- To lessen your exposure to noise and to protect your hearing against injury, wear ear-protectors!



Keep other people - especially children - well away from the equipment and the welding operation while this is in progress. If there are still any other persons nearby during welding, you must

- draw their attention to all the dangers (risk of being dazzled by the arc or injured by flying sparks, harmful welding fumes, high noise immission levels, possible hazards from mains or welding current ...)
- provide them with suitable protective equipment and/or
- erect suitable protective partitions or curtains.

Information on noise emission values



The device generates a maximum sound power level of <math><80\text{ dB(A)}</math> (ref. 1pW) when idling and in the cooling phase following operation at the maximum permissible operating point under maximum rated load conditions according to EN 60974-1.

It is not possible to provide a workplace-related emission value during welding (or cutting) as this is influenced by both the process and the environment. All manner of different welding parameters come into play, including the welding process (MIG/MAG, TIG welding), the type of power selected (DC or AC), the power range, the type of weld metal, the resonance characteristics of the workpiece, the workplace environment, etc.

Hazards from noxious gases and vapours



The fumes given off during welding contain gases and vapours that are harmful to health.

Welding fumes contain substances which may cause birth defects and cancers.

Keep your head away from discharges of welding fumes and gases.

Do not inhale any fumes or noxious gases that are given off.
Extract all fumes and gases away from the workplace, using suitable means.

Ensure a sufficient supply of fresh air.

Where insufficient ventilation is available, use a respirator mask with an independent air supply.

If you are not sure whether your fume-extraction system is sufficiently powerful, compare the measured pollutant emission values with the permitted threshold limit values.

Hazards from noxious gases and vapours
(continued)

The harmfulness of the welding fumes will depend on e.g. the following components:

- the metals used in and for the workpiece
- the electrodes
- coatings
- cleaning and degreasing agents and the like

For this reason, pay attention to the relevant Materials Safety Data Sheets and the information given by the manufacturer regarding the components listed above.

Keep all flammable vapors (e.g. from solvents) well away from the arc radiation.

Hazards from flying sparks



Flying sparks can cause fires and explosions!

Never perform welding anywhere near combustible materials.

Combustible materials must be at least 11 meters (35 feet) away from the arc, or else must be covered over with approved coverings.

Have a suitable, approved fire extinguisher at the ready.

Sparks and hot metal particles may also get into surrounding areas through small cracks and openings. Take suitable measures here to ensure that there is no risk of injury or fire.

Do not perform welding in locations that are at risk from fire and/or explosion, or in enclosed tanks, barrels or pipes, unless these latter have been prepared for welding in accordance with the relevant national and international standards.

Welding must NEVER be performed on containers that have had gases, fuels, mineral oils etc. stored in them. Even small traces of these substances left in the containers are a major explosion hazard.

Hazards from mains and welding current



An electric shock is potentially life-threatening, and can be fatal.

Do not touch any live parts, either inside or outside the machine.



In MIG/MAG and TIG welding, the welding wire, the wire spool, the drive rollers and all metal parts having contact with the welding wire are also live.

Always place the wirefeeder on an adequately insulated floor or base, or else use a suitable insulating wirefeeder holder.

Ensure sufficient protection for yourself and for other people by means of a dry base or cover that provides adequate insulation against the ground/frame potential. The base or cover must completely cover the entire area between your body and the ground/frame potential.

All cables and other leads must be firmly attached, undamaged, properly insulated and adequately dimensioned. Immediately replace any loose connections, scorched, damaged or underdimensioned cables or other leads.



Hazards from mains and welding current

(continued)

Do not loop any cables or other leads around your body or any part of your body.

Never immerse the welding electrode (rod electrode, tungsten electrode, welding wire, ...) in liquid in order to cool it, and never touch it when the power source is ON.

Twice the open-circuit voltage of one single welding machine may occur between the welding electrodes of two welding machines. Touching the potentials of both electrodes simultaneously may be fatal.

Have the mains and the machine supply leads checked regularly by a qualified electrician to ensure that the PE (protective earth) conductor is functioning correctly.

Only run the machine on a mains network with a PE conductor, and plugged into a power outlet socket with a protective-conductor contact.

If the machine is run on a mains network without a PE conductor and plugged into a power outlet socket without a protective-conductor contact, this counts as gross negligence and the manufacturer shall not be liable for any resulting damage.

Wherever necessary, use suitable measures to ensure that the workpiece is sufficiently grounded (earthed).

Switch off any appliances that are not in use.

Wear a safety harness if working at height.

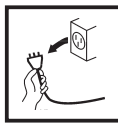

Before doing any work on the machine, switch it off and unplug it from the mains.

Put up a clearly legible and easy-to-understand warning sign to stop anybody inadvertently plugging the machine back into the mains and switching it back on again.

After opening up the machine:

- discharge any components that may be storing an electrical charge
- ensure that all machine components are electrically dead.

If work needs to be performed on any live parts, there must be a second person on hand to immediately switch off the machine at the main switch in an emergency.

Stray welding currents



If the following instructions are ignored, stray welding currents may occur. These can cause:

- fires
- overheating of components that are connected to the workpiece
- destruction of PE conductors
- damage to the machine and other electrical equipment

Ensure that the workpiece clamp is tightly connected to the workpiece.

Attach the workpiece clamp as close as possible to the area to be welded.

On electrically conductive floors, the machine must be set up in such a way that it is sufficiently insulated from the floor.

Stray welding currents (continued)

When using current supply distributors, twin head wire feeder fixtures etc., please note the following: The electrode on the unused welding torch/welding tongs is also current carrying. Please ensure that there is sufficient insulating storage for the unused welding torch/tongs.

In the case of automated MIG/MAG applications, ensure that only insulated filler wire is routed from the welding wire drum, large wirefeeder spool or wirepool to the wirefeeder.



EMC device classifications



Devices with emission class A:

- are only designed for use in an industrial setting
- can cause conducted and emitted interference in other areas.

Devices with emission class B:

- satisfy the emissions criteria for residential and industrial areas. This also applies to residential areas in which power is supplied from the public low-voltage grid.

EMC device classification as per the rating plate or technical specifications

EMC measures



In certain cases, even though a device complies with the standard limit values for emissions, it may affect the application area for which it was designed (e.g. when there is sensitive equipment at the same location, or if the site where the device is installed is close to either radio or television receivers).

If this is the case, then the operator is obliged to take appropriate action to rectify the situation.

Examine and evaluate any possible electromagnetic problems that may occur on equipment in the vicinity, and the degree of immunity of this equipment, in accordance with national and international regulations:

- safety features
- mains, signal and data-transmission leads
- IT and telecoms equipment
- measurement and calibration devices

Ancillary measures for preventing EMC problems:

a) Mains supply

- If electromagnetic interference still occurs, despite the fact that the mains connection is in accordance with the regulations, take additional measures (e.g. use a suitable mains filter).

b) Welding cables

- Keep these as short as possible
- Arrange them so that they run close together (to prevent EMI problems as well)
- Lay them well away from other leads.

c) Equipotential bonding

d) Workpiece grounding (earthing)

- where necessary, run the connection to ground (earth) via suitable capacitors.

e) Shielding, where necessary

- Shield other equipment in the vicinity
- Shield the entire welding installation.

EMI Precautions



Electromagnetic fields may cause as yet unknown damage to health.

- Effects on the health of persons in the vicinity, e.g. users of heart pacemakers and hearing aids
- Users of heart pacemakers must take medical advice before going anywhere near welding equipment or welding workplaces
- Keep as much space as possible between welding cables and head/body of welder for safety reasons
- Do not carry welding cables and hose pack over shoulder and do not loop around body or any part of body

Particular danger spots



Keep your hands, hair, clothing and tools well away from all moving parts, e.g.:

- fans
- toothed wheels, rollers, shafts
- wire-spools and welding wires

Do not put your fingers anywhere near the rotating toothed wheels of the wirefeed drive.

Covers and sideguards may only be opened or removed for as long as is absolutely necessary to carry out maintenance and repair work.

While the machine is in use:

- ensure that all the covers are closed and that all the sideguards are properly mounted ...
- ... and that all covers and sideguards are kept closed.



When the welding wire emerges from the torch, there is a high risk of injury (the wire may pierce the welder's hand, injure his face and eyes ...). For this reason, when feeder-inching etc., always hold the torch so that it is pointing away from your body (machines with wirefeeder).



Do not touch the workpiece during and after welding - risk of injury from burning!

Slag may suddenly "jump" off workpieces as they cool. For this reason, continue to wear the regulation protective gear, and to ensure that other persons are suitably protected, when doing post-weld finishing on workpieces.

Allow welding torches - and other items of equipment that are used at high operating temperatures - to cool down before doing any work on them.



Special regulations apply to rooms at risk from fire and/or explosion. Observe all relevant national and international regulations.



Power sources for use in spaces with increased electrical danger (e.g. boilers) must be identified by the  (for "safety") mark. However, the power source should not be in such rooms.



Risk of scalding from accidental discharge of hot coolant. Before unplugging the connectors for coolant forward flow and return flow, switch off the cooling unit.

Particular danger spots
(continued)



When hoisting the machines by crane, only use suitable manufacturer-supplied lifting devices.

- Attach the chains and/or ropes to **all** the hoisting points provided on the suitable lifting device.
- The chains and/or ropes must be at an angle which is as close to the vertical as possible.
- Remove the gas cylinder and the wirefeed unit (from MIG/MAG and TIG units).

When hoisting the wirefeed unit by crane during welding, always use a suitable, insulating suspension arrangement (MIG/MAG and TIG units).

If a machine is fitted with a carrying strap or carrying handle, remember that this strap is **ONLY** to be used for lifting and carrying the machine by hand. The carrying strap is **NOT** suitable for transporting the machine by crane, fork-lift truck or by any other mechanical hoisting device.



Danger of colourless and odourless inert gas escaping unnoticed, when using an adapter for the inert gas protection. Seal the adapter thread for the inert gas connection using Teflon tape before assembly.

Danger from shielding-gas cylinders



Shielding-gas cylinders contain pressurized gas and may explode if they are damaged. As shielding-gas cylinders are an integral part of the overall welding outfit, they also have to be treated with great care.

Protect shielding-gas cylinders containing compressed gas from excessive heat, mechanical impact, slag, naked flames, sparks and arcs.

Mount the shielding-gas cylinders in the vertical and fasten them in such a way that they cannot fall over (i.e. as shown in the instruction manual).

Keep shielding-gas cylinders well away from welding circuits (and, indeed, from any other electrical circuits).

Never hang a welding torch on a shielding-gas cylinder.

Never touch a shielding-gas cylinder with a welding electrode.

Explosion hazard - never perform welding on a pressurized shielding-gas cylinder.

Use only shielding-gas cylinders that are suitable for the application in question, together with matching, suitable accessories (pressure regulators, hoses and fittings, ...). Only use shielding-gas cylinders and accessories that are in good condition.

When opening the valve of a shielding-gas cylinder, always turn your face away from the outlet nozzle.

Close the shielding-gas cylinder valve when no welding is being carried out.

When the shielding-gas cylinder is not connected up, leave the cap in place on the shielding-gas cylinder valve.

Observe the manufacturer's instructions and all relevant national and international rules applying to shielding-gas cylinders and accessories.



Safety precautions at the installation site and when being transported

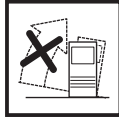

A machine that topples over can easily kill someone! For this reason, always place the machine on an even, firm floor in such a way that it stands firmly.

- An angle of inclination of up to 10° is permissible.



Special regulations apply to rooms at risk from fire and/or explosion. Observe all relevant national and international regulations.

By means of internal instructions and checks, ensure that the workplace and the area around it are always kept clean and tidy.

The appliance must only be installed and operated in accordance with the protection type stated on the specifications plate.

When installing the appliance, please ensure a clearance radius of 0.5 m (1.6ft.) , so that cool air can circulate freely.

When transporting the appliance, please ensure that the valid national and regional guidelines and accident protection regulations are followed. This applies in particular to guidelines in respect of dangers during transportation and carriage.

Before transportation, completely drain any coolant and dismantle the following components:

- Wire feed
- Wire wound coil
- Gas bottle

Before commissioning and after transportation, a visual check for damage must be carried out. Any damage must be repaired by trained service personnel before commissioning.

Safety precautions in normal operation



Only operate the machine if all of its protective features are fully functional. If any of the protective features are not fully functional, this endangers:

- the life and well-being of the operator or other persons
- the equipment and other tangible assets belonging to the owner/operator
- efficient working with the equipment.

Any safety features that are not fully functional must be put right before you switch on the machine.

Never evade safety features and never put safety features out of order.

Before switching on the machine, ensure that nobody can be endangered by your doing so.

- At least once a week, check the machine for any damage that may be visible from the outside, and check that the safety features all function correctly.
- Always fasten the shielding-gas cylinder firmly, and remove it altogether before hoisting the machine by crane.
- Owing to its special properties (in terms of electrical conductivity, frost-proofing, materials-compatibility, combustibility etc.), only original coolant of the manufacturer is suitable for use in our machines.
- Only use suitable original coolant of the manufacturer.
- Do not mix original coolant of the manufacturer with other coolants.

Safety precautions in normal operation

(continued)

- If any damage occurs in cases where other coolants have been used, the manufacturer shall not be liable for any such damage, and all warranty claims shall be null and void.
- Under certain conditions, the coolant is flammable. Only transport the coolant in closed original containers, and keep it away from sources of ignition.
- Used coolant must be disposed of properly in accordance with the relevant national and international regulations. A safety data sheet is available from your service centre and on the manufacturer's homepage.
- Before starting welding - while the machine is still cool - check the coolant level.



Preventive and corrective maintenance



With parts sourced from other suppliers, there is no certainty that these parts will have been designed and manufactured to cope with the stressing and safety requirements that will be made of them. Use only original spares and wearing parts (this also applies to standard parts).

Do not make any alterations, installations or modifications to the machine without getting permission from the manufacturer first.

Replace immediately any components that are not in perfect condition.

When ordering spare parts, please state the exact designation and the relevant part number, as given in the spare parts list. Please also quote the serial number of your machine.

Safety inspection



The owner/operator is obliged to have a safety inspection performed on the machine at least once every 12 months.

The manufacturer also recommend the same (12-month) interval for regular calibration of power sources.

A safety inspection, by a trained and certified electrician, is prescribed:

- after any alterations
- after any modifications or installations of additional components
- following repairs, care and maintenance
- at least every twelve months.

Observe the relevant national and international standards and directives in connection with the safety inspection.

More detailed information on safety inspections and calibration is available from your regional or national service centre, who will be pleased to provide you with copies of the necessary documents upon request.

Disposal



Do not dispose of this device with normal domestic waste!

To comply with the European Directive 2002/96/EC on Waste Electrical and Electronic Equipment and its implementation as national law, electrical equipment that has reached the end of its life must be collected separately and returned to an approved recycling facility. Any device that you no longer require must be returned to our agent, or find out about the approved collection and recycling facilities in your area.

Ignoring this European Directive may have potentially adverse effects on the environment and your health!

Safety markings



Equipment with CE-markings fulfils the basic requirements of the Low-Voltage and Electromagnetic Compatibility Guideline (e.g. relevant product standards according to EN 60 974). .



Equipment marked with the CSA-Test Mark fulfils the requirements made in the relevant standards for Canada and the USA.

Data security

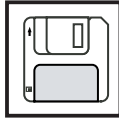

The user is responsible for the data security of changes made to factory settings. The manufacturer is not liable, if personal settings are deleted.

Copyright



Copyright to this instruction manual remains the property of the manufacturer.

The text and illustrations are all technically correct at the time of going to print. The right to effect modifications is reserved. The contents of the instruction manual shall not provide the basis for any claims whatever on the part of the purchaser. If you have any suggestions for improvement, or can point out to us any mistakes which you may have found in the manual, we should be most grateful for your comments.

Table of contents

General.....	3
Machine concept	3
Field of application	3
Proper use.....	3
Warning notices affixed to the oscillation unit.....	4
Scope of supply.....	4
Control elements and connections.....	5
Oscillation unit control panel	5
Start-up.....	6
Mounting the oscillation unit.....	6
Preparing system components.....	6
Set the oscillation	7
Start the welding process	7
Troubleshooting.....	8
General.....	8
Basic requirements for the system to work	8
Oscillation.....	8
Maintenance and care.....	9
Personnel	9
Maintenance activities.....	9
Technical data	10
Oscillation unit FOU-30 / ML6	10
Dimensions of oscillation unit with driving vehicle.....	10
Spare parts list FOU-30 / ML6.....	11
Circuit diagram FOU-30 / ML6	15
EU-Declaration of incorporation	16

General

Machine concept



Oscillation unit FOU-30/ML6

The oscillation unit FOU-30/ ML6 is an optional expansion for the driving vehicle FDV-22 MF. The system is used to execute mechanised butt and fillet welds in horizontal or vertical welding positions. Oscillating makes it possible to produce broad weld seams. The oscillating parameters determine the appearance and quality of the weld seam.

The universal torch holder is mounted on the side support arm. It is connected to the driving vehicle via a flanged plug connector.

Field of application

The oscillation unit is only to be used in conjunction with the driving vehicle FDV 22 MF. The system can be used in all situations where a high degree of flexibility is required when executing longitudinal weld seams:

- Welding of longitudinal members
- Shipyards
- Bridge construction
- Workshops
- Production halls
- Building sites

Proper use

The oscillation unit FOU-30/ML6 is an optional expansion for the driving vehicle FDV-22 MF and is used for performing mechanised butt and fillet welds in horizontal or vertical welding positions. The oscillation unit is only to be used in conjunction with the driving vehicle FDV -22 MF. Any use above and beyond this purpose is deemed improper. The manufacturer shall not be liable for any damage resulting from such improper use.

The following welding processes are possible:

- MIG/MAG process

Proper use also includes:



- use of MIG / MAG welding torches with a holder diameter of 16 - 22 mm
- using the spare parts stipulated by Fronius
- following all the information in the operating instructions
- using this document in conjunction with the operating instructions of the integrated system components (driving vehicle, power source, wire-feed unit, etc.)

**Warning notices
affixed to the
oscillation unit**

The oscillation unit has safety symbols on the rating plate. These safety symbols must NOT be removed or painted over.

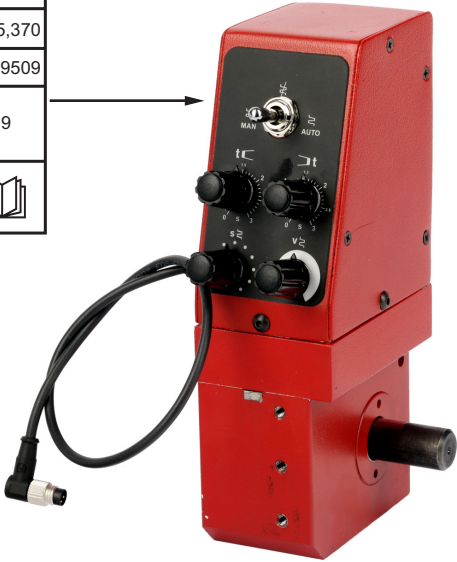
 A-4600 Wels www.fronius.com		Type:	FOU 30/ML6	
		Art.No.:	8,045,370	
		Ser.No.:	20 26 9509	
U	weight	max. load	2009	
14,4 VDC	2,5 kg	6 kg		



Do not use the functions until you have fully read all the operating instructions.



Do not dispose of used chargers with domestic waste. Dispose of them according to safety rules.

Rating plate FOU-30/ ML6

Scope of supply

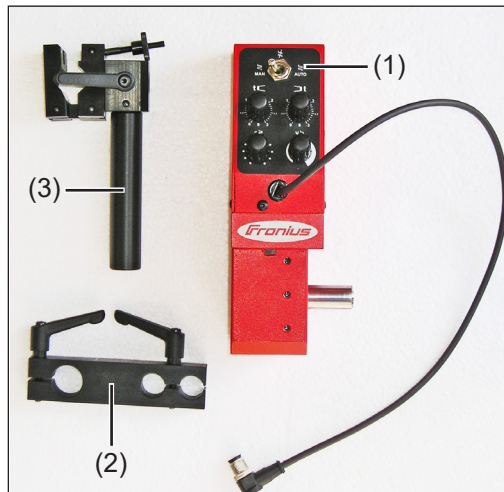

- (1) Oscillation unit FOU-30/ML6
- (2) Clamp block
- (3) Linkage with universal torch holder

FOU-30/ ML6 scope of supply

Control elements and connections

Oscillation unit control panel



WARNING! Operating the equipment incorrectly can cause serious injury and damage. Do not use the functions described until you have thoroughly read and understood the following documents:

- these operating instructions
- all the operating instructions for the system components, especially the safety rules

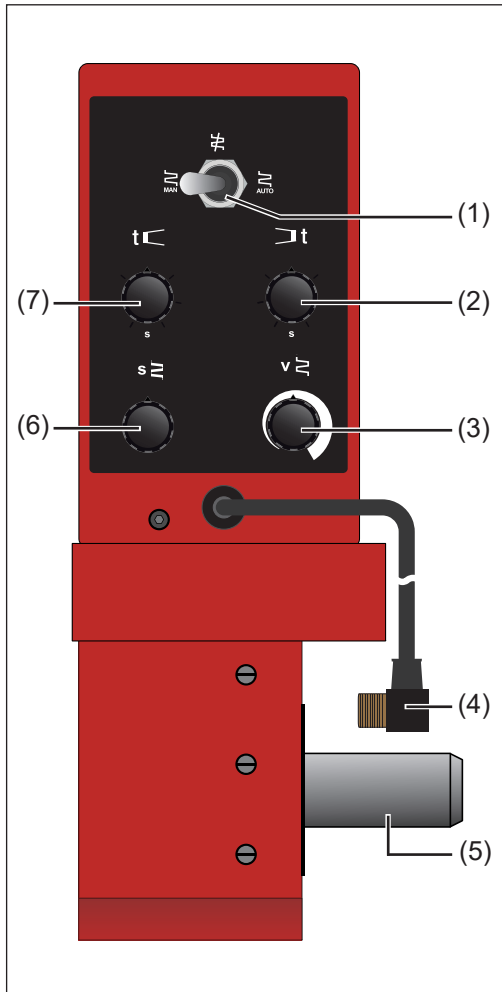

Oscillation unit FOU-30/ML6 control panel

No. Function

- | | |
|-----|---|
| (1) | <p>Oscillation mode toggle switch
MANUAL / OFF / AUTOMATIC</p> <p>For selecting the oscillating mode of the FOU -30.
MANUAL: Oscillating active immediately
OFF: Oscillating is deactivated
AUTOMATIC: Oscillating starts simultaneously with program sequence.</p> |
| (2) | <p>Right dwell time potentiometer</p> <p>For setting the dwell time of the torch in the right reversal position.
Setting range: 0 - 3 seconds</p> |
| (3) | <p>Oscillation speed potentiometer</p> <p>For setting the traversing speed of the oscillation unit in mm / min. The oscillating speed can only be adjusted while the oscillation unit is running.</p> |
| (4) | <p>Connection cable with male socket</p> <p>For connection to the "Connector for oscillation unit FOU30" of the driving vehicle control panel.</p> |
| (5) | <p>Support arm</p> <p>For fastening the torch holder.</p> |
| (6) | <p>Oscillation path potentiometer</p> <p>To increase or reduce the oscillating path (oscillating width).
The oscillating path can only be adjusted while the oscillation unit is running.
Setting range: 1 - 30 mm</p> |

- | | |
|-----|--|
| (7) | <p>Left dwell time potentiometer</p> <p>For setting the dwell time of the torch in the left reversal position.
Setting range: 0 - 3 seconds</p> |
|-----|--|

Start-up

Mounting the oscillation unit



WARNING! Operating the equipment incorrectly can cause serious injury and damage. Do not use the functions described until you have thoroughly read and understood the following documents:

- these operating instructions
- all the operating instructions for the system components, especially the safety rules

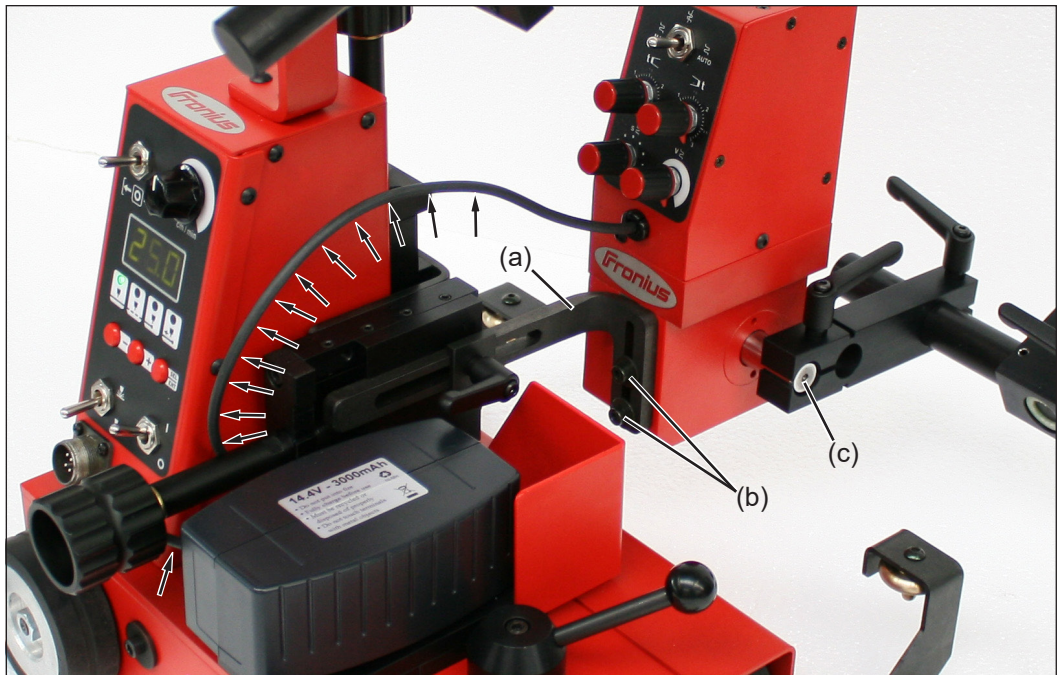

Mounting the oscillation unit FOU-30/ML6

1. Affix the oscillation unit FOU-30/ML6 on the adjustable mount (a) using 2 Allen screws M5 x 16 and washers 5.3 . Adjust the oscillation unit to the required height (with the slots) and tighten the Allen screws (b).
2. Lay the connecting cable on the driving vehicle as shown.
3. Connect the flanged plug connector to the socket  on the driving vehicle control panel.
4. Push the torch holder linkage on the support arm (c). Turn the linkage to the desired position and tighten the lever.

Preparing system components

The following activities and work steps apply to the installed system. All connections must be established. Before start-up, check the connections of the following system components:

- Driving vehicle
- Power source
- Cooling circuit
- Gas cylinder
- Wire-feed unit
- Welding torch with hosepack

Detailed information on the preparation of the system components can be found in the corresponding operating instructions for the system components (driving vehicle, power source, wire-feed unit, etc.)

Set the oscillation

The oscillating parameters determine the appearance and quality of the weld seam. Observe the following procedure:



1. Set the "Start LEFT / STOP / Start RIGHT" toggle switch on the driving vehicle control panel to the "STOP" (0) position.



2. Turn the "Control unit ON/OFF" toggle switch to the "ON" position

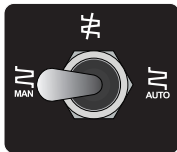

3. Start trial run. Turn the "Oscillation mode MANUAL / OFF / AUTOMATIC" toggle switch to the "MANUAL" position.

4. Observe the oscillating motion and set the following oscillating parameters:

t dwell time left [s]

t dwell time right [s]

s oscillating path [mm]

v oscillating speed [mm]

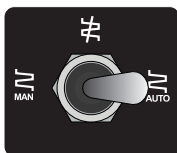

5. Turn the "Oscillation mode MANUAL / OFF / AUTOMATIC" toggle switch to the "AUTOMATIC" position. Oscillating starts at the same time as the program sequence.

Important: If the driving vehicle has been configured for interval welding, the oscillating motion is only active in the welding segment. In the pause segment, during crater filling and back-filling, the oscillation unit stops and waits in the middle position.

Start the welding process

1. Turn the "Start LEFT / STOP / Start RIGHT" toggle switch on the driving vehicle control panel to the desired setting. To stop the process early, turn the switch to the "STOP" (0) position.

2. Make any necessary corrections (welding torch position, direction of travel, traversing speed, oscillating motion, etc.).

Troubleshooting

General

In the event of faults, note that the functioning of the entire system depends on many additional components (driving vehicle, power source, wire-feed unit, etc.) that are also potential sources of problems.

Basic requirements for the system to work

- Connections established between separate system components
- System components are supplied with electricity and the mains voltage for each component complies with the rating plate

Oscillation

Oscillation does not work

Cause: "Oscillation mode MANUAL / OFF / AUTOMATIC" toggle switch is in the "OFF" position.

Remedy: Turn toggle switch to the "MANUAL" or "AUTOMATIC" position.

Cause: Connecting cable to the driving vehicle control unit damaged.

Remedy: Check the connecting cable. Replace if necessary.

Cause: oscillating arm blocked.

Remedy: Check that the oscillating arm, linkage and torch holder move freely.

Oscillation unit is not oscillating, motor audible

Cause: Transmission damaged.

Remedy: Replace transmission.

Maintenance and care

Personnel



WARNING! Risk of injury and damage from incorrectly performed maintenance.

All maintenance on the FDV 22 MF driving vehicle must only be carried out by trained technicians. It is essential to adhere to the maintenance intervals and maintenance procedures. The manufacturer accepts no liability for any damage caused by inadequate or poorly performed maintenance.

Maintenance activities

Under normal operating conditions the unit requires only a minimum of care and maintenance. However, it is vital to observe some important points to ensure it remains in a usable condition for many years.

- Check the connecting cable to the driving vehicle for damage.
- Check the torch holder for damage

Technical data

Oscillation unit FOU -30 / ML6

Max. load	6 kg
Max. torque	6 Nm
Oscillating process	angled, max. 11°
Oscillating path	1 - 30 mm
Oscillating frequency (R = 150, oscillation path = 10 mm)	12 - 110 strokes / min
Dwell time	0 - 3 sec.

Dimensions of oscillation unit with driving vehicle

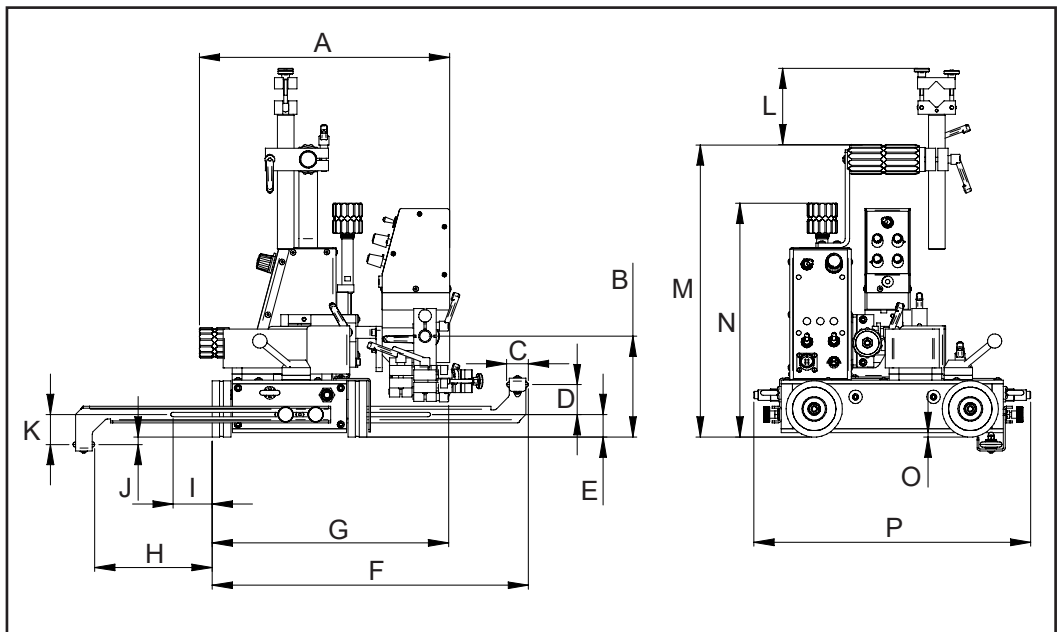

A	305 - 415 mm
B	112 - 162 mm
C	29 mm
D	40 mm
E	30 mm
F	271 - 421 mm
G	288 - 398 mm
H	157 mm

I	52 mm
J	10 mm
K	40 mm
L	60 - 200 mm
M	398 mm
N	312 mm
O	5 mm
P	369 mm

Spare parts list FOU-30 / ML6



Oscillation unit FOU-30/ML6 8,045,370

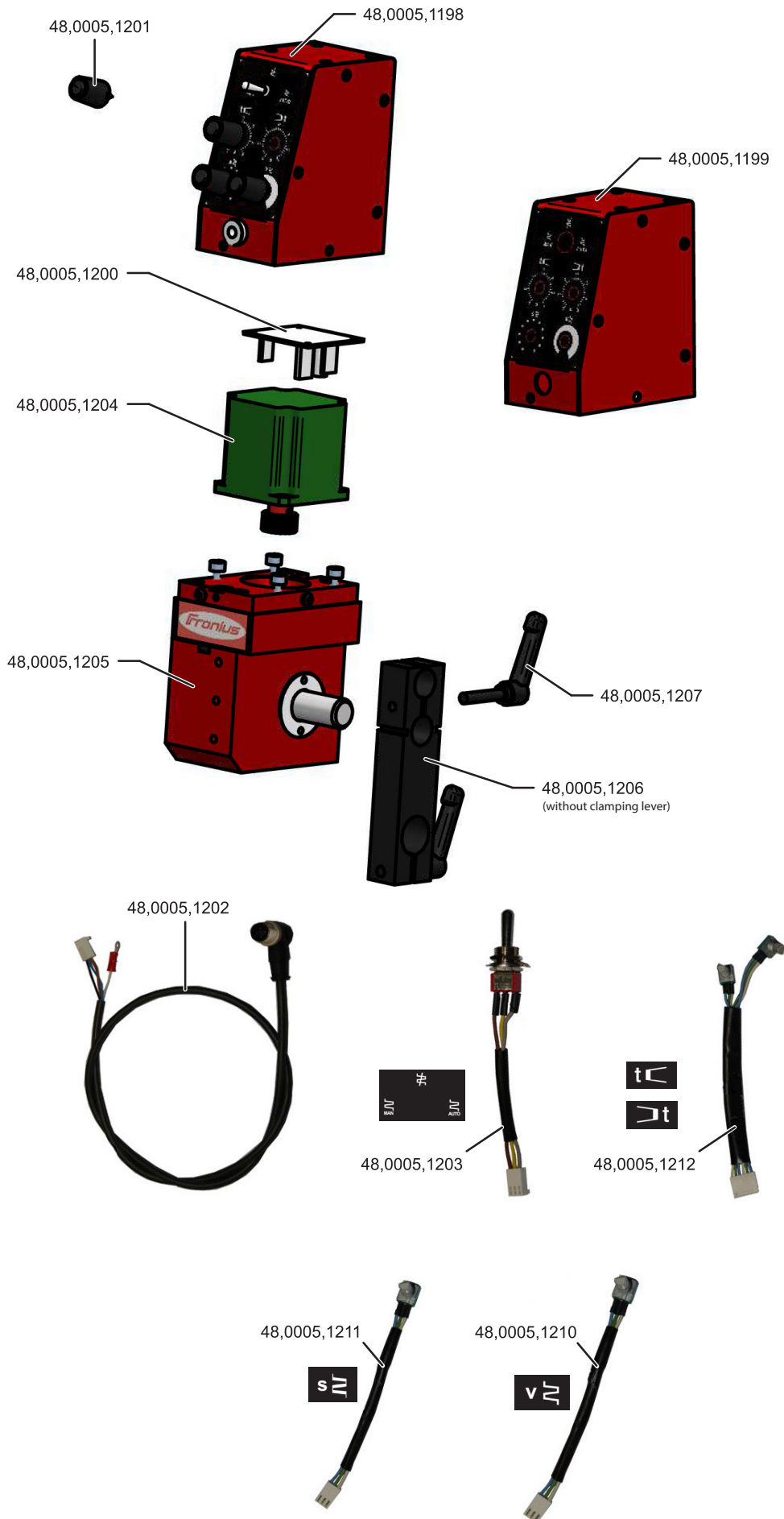

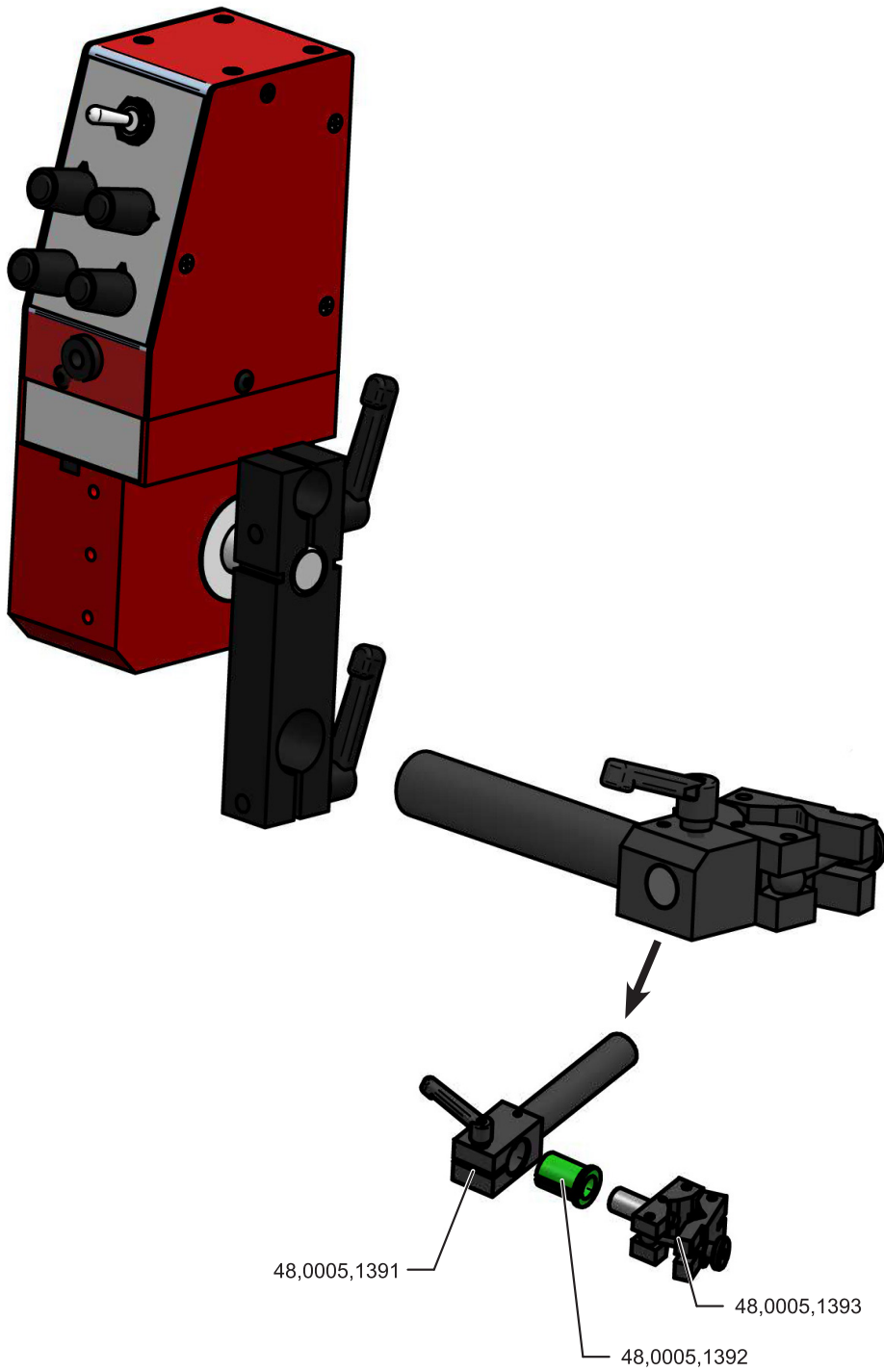

EU-Declaration of incorporation



EU-EINBAUERKLÄRUNG 2016 EU DECLARATION OF INCORPORATION 2016 DECLARATION D' INCORPORATION DE U.E., 2016

Wels-Thalheim, 2016-04-20

Die Firma

Manufacturer

La compagnie

FRONIUS INTERNATIONAL GMBH

Froniusplatz 1, 4600 Wels

Hiermit erklären wir, dass folgendes Produkt:

FOU 30/ML6
FOU 30/ML10
FOU 40/ML5
FOU 50/ML10
FOU 100/ML10
ACC Modul
Schweißzubehör

We hereby declare that the following product:

FOU 30/ML6
FOU 30/ML10
FOU 40/ML5
FOU 50/ML10
FOU 100/ML10
ACC Modul
Arc welding equipment

Nous déclarons par la présente que le produit suivant:

FOU 30/ML6
FOU 30/ML10
FOU 40/ML5
FOU 50/ML10
FOU 100/ML10
ACC Modul
Accessoires de soudage

den unten angeführten, grundlegenden Anforderungen einer „unvollständigen Maschine“ im Sinne der Maschinenrichtlinie 2006/42/EG entspricht. Das Produkt ist ausschließlich zum Einbau in eine Maschine oder unvollständige Maschine vorgesehen und entspricht daher noch nicht sämtlichen Anforderungen der Maschinenrichtlinie. Die Inbetriebnahme des Produkts ist solange untersagt, bis festgestellt wurde, dass die Maschine, in die das o. g. Produkt eingebaut wird, allen grundlegenden Anforderungen der Maschinenrichtlinie 2006/42/EG entspricht. Die speziellen technischen Unterlagen gemäß Anhang VII Teil B wurden erstellt.

conforms to the essential requirements listed below of "partly completed machinery" within the meaning of the Machinery Directive, 2006/42/EU. The product is intended exclusively for installation in machinery or partly completed machinery. It therefore does not yet fully conform to all the requirements of the Machinery Directive. It is not permitted to commission the product until it has been established that the machinery in which the above product is installed conforms to all the requirements of the Machinery Directive, 2006/42/EU. The special technical documents according to Annex VII Part B have been created.

répond aux exigences essentielles indiquées ci-dessous, relatives à celles d'une « quasi-machine » au sens de la directive machines 2006/42/CE. Le produit est exclusivement prévu pour un montage dans une machine ou une quasi-machine et ne répond donc pas encore à toutes les exigences de la directive machines. La mise en service du produit est interdite jusqu'à ce qu'il soit constaté que la machine dans laquelle le produit précité a été monté, est en conformité avec toutes les exigences de la directive machines 2006/42/CE. Les documents techniques spéciaux, conformément à l'annexe VII Partie B, ont été élaborés.

Richtlinie 2006/42/EG
Maschinenrichtlinie
Anhang I: 1.1.3, 1.1.5, 1.3.2, 1.3.3,
1.3.8

Directive 2006/42/EC
Machinery Directive
Annex I: 1.1.3, 1.1.5, 1.3.2, 1.3.3,
1.3.8

Directive 2006/42/CE
Directive aux machines
Annexe I: 1.1.3, 1.1.5, 1.3.2, 1.3.3,
1.3.8

Dokumentationsverantwortlicher:
(technische Dokumentation)

person responsible for documents:
(technical documents)

responsable documentation:
(technique documentation)

Ing. Josef Feichtinger
Günter Fronius Straße 1
A - 4600 Wels-Thalheim

Ing. Josef Feichtinger
Günter Fronius Straße 1
A - 4600 Wels-Thalheim

Ing. Josef Feichtinger
Günter Fronius Straße 1
A - 4600 Wels-Thalheim

2016

ppa. Mag. Ing. H. Hackl
Member of Board
Chief Technology Officer

DE German

Deutsch

EN English

English

FR French

Française



FRONIUS INTERNATIONAL GMBH
TechSupport Automation

Froniusplatz 1, A-4600 Wels, Austria

E-Mail: support.automation@fronius.com
www.fronius.com

www.fronius.com/addresses

Under <http://www.fronius.com/addresses> you will find all addresses
of our Sales & service partners and Locations.

