

Quick Start Guide

Fronius Smart Meter TS 5kA-3

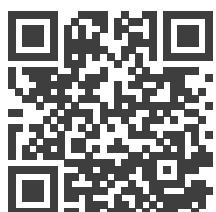

[manuals.fronius.com/
html/4204260348](https://manuals.fronius.com/html/4204260348)

**OPERATING
INSTRUCTION**



Technical Data - General	
Nominal voltage (3-phase)	400 - 480 V
Operating range (class 1)	320 - 552 V
Operating range (class 2)	173 - 400 VLL ± (2 % RDG/accuracy)
Nominal voltage (1-phase)	230 - 277 V
Operating range (class 1)	184 - 318,55 V
Operating range (class 2)	100 - 230 VLN ± (1 % RDG/accuracy)
Nominal frequency / Tolerance	50 - 60 Hz / 45 - 65 Hz
Nominal / Maximum current	1 A + 5 A / 6 A
Powerfactor range (EN/IEC 62053-21, EN/IEC 62053-23)	aktiv $\cos\phi$ 0.5 ind to 0.8 cap reaktiv $\sin\phi$ 0.5 ind to 0.5 cap
Current transformer ratio (kCT)	1 - 1000 e. g. TC 800/5A kCT = 160 for direct connection: kCT = 1
Voltage transformer ratio (kVT)	1 - 1000 e. g. VT 20000/400V kVT = 50 for direct connection: kVT = 1
Maximum value kVT x kCT	1000 (CT/5A)
Permitted ambient temperature	from -25° to +65°C
Mounting	DIN rail 35 mm
IP range (EN60529)	IP54 / IP20 (Front / Connections)

Communication	
Standard	RS485 - 3 conductors
Protocol	Modbus RTU
Min. Softwareversion	Datamanager 2.0: 3.16.1 / Fronius Symo Hybrid: 1.16.1 / Fronius GEN24: 1.12.1

Screw terminal	
Measuring input / neutral line	1 - 4 mm ²
Output (data communication /Auxiliary power supply)	0,05 - 2,5 mm ²
Recommended torque	Measuring input: max. 0,6 Nm Output / Auxiliary power supply: max. 0,4 Nm

Detailed, country-specific warranty terms are available on: www.fronius.com/solar/warranty

AC~

Mounting

Auxiliary Power Supply

Power Wiring

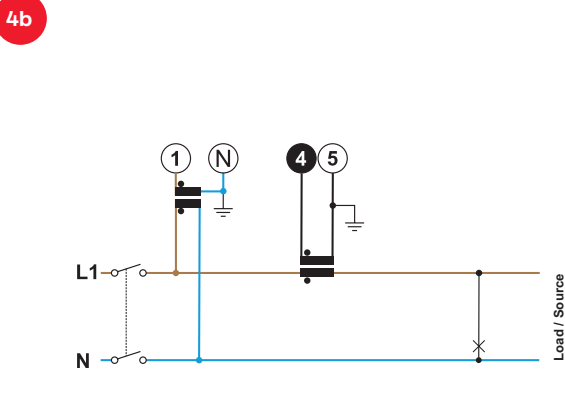
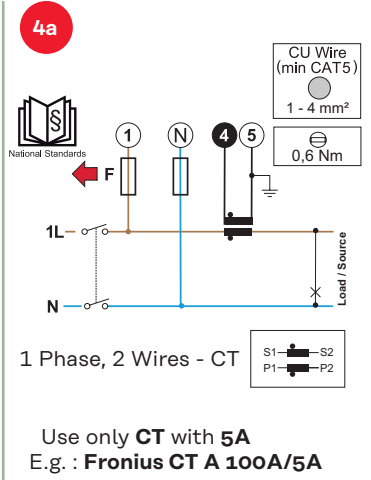
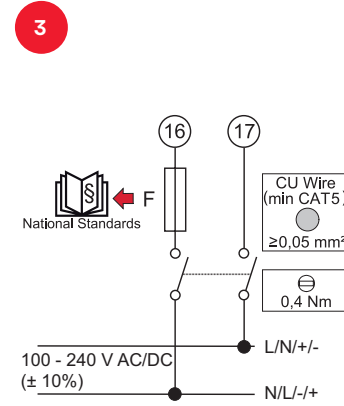
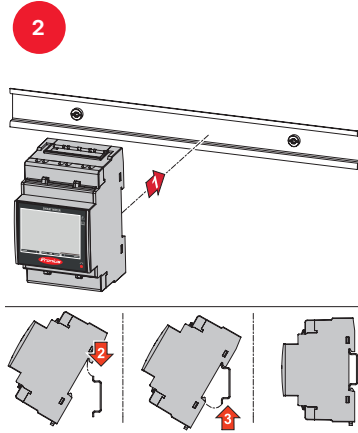
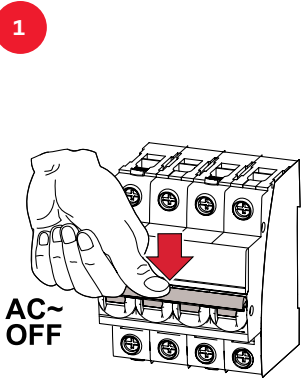

1 Phase, 2 Wires - VT/CT

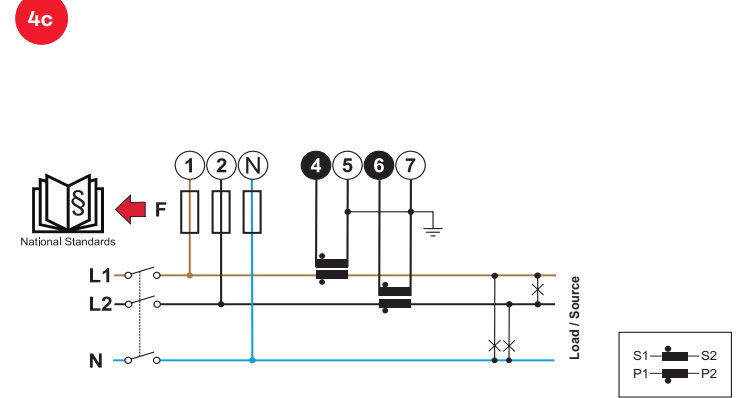

2 Phases, 3 Wires - CT

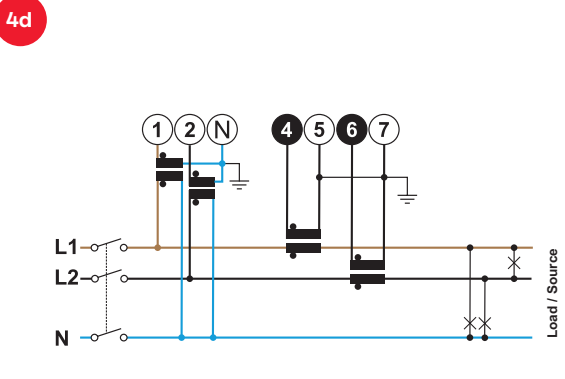

2 Phases, 3 Wires - VT/CT

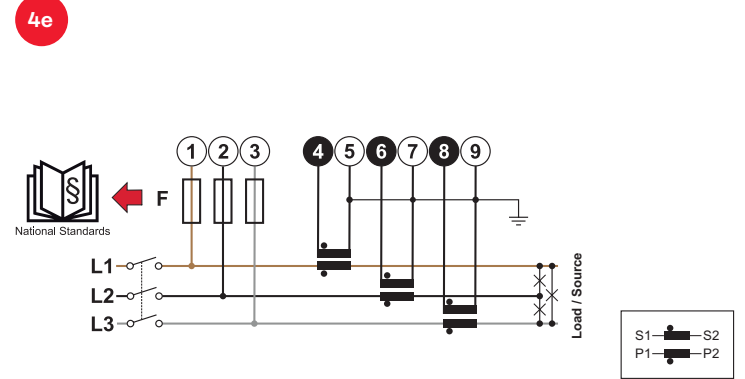

3 Phases, 3 Wires - CT

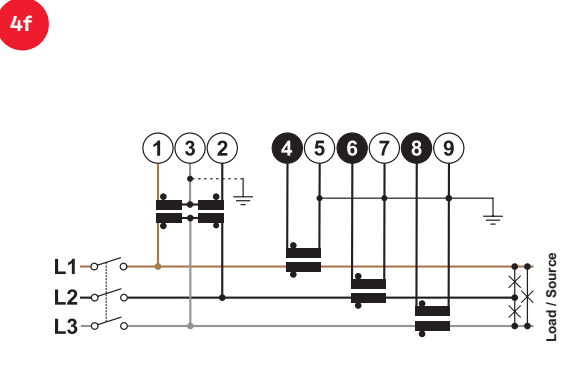

3 Phases, 3 Wires - VT/CT

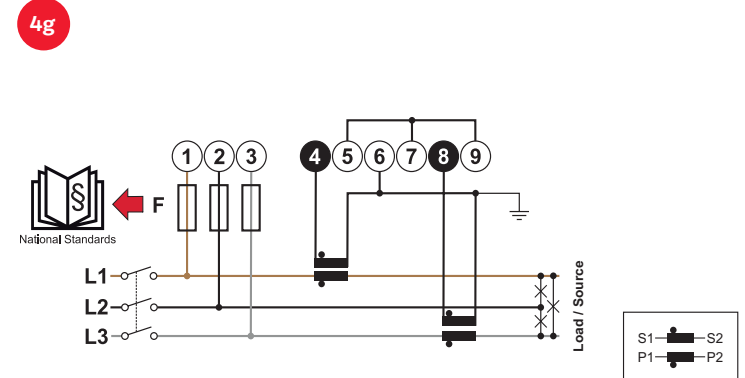

3 Phases, 4 Wires - Aron CT

4h

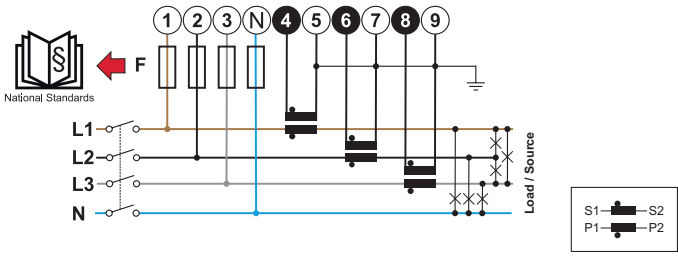

3 Phases, 4 Wires - CT

4i

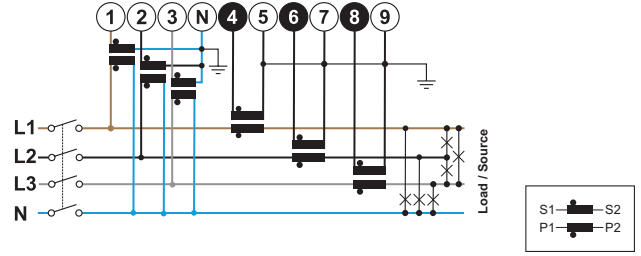

3 Phases, 4 Wires - VT/CT

Data wiring

5

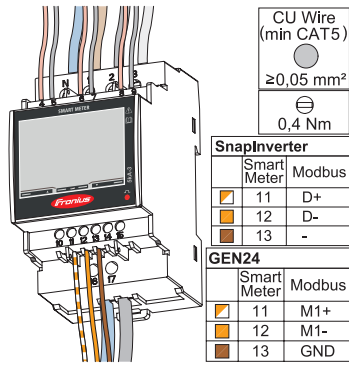

Terminating Resistor

6

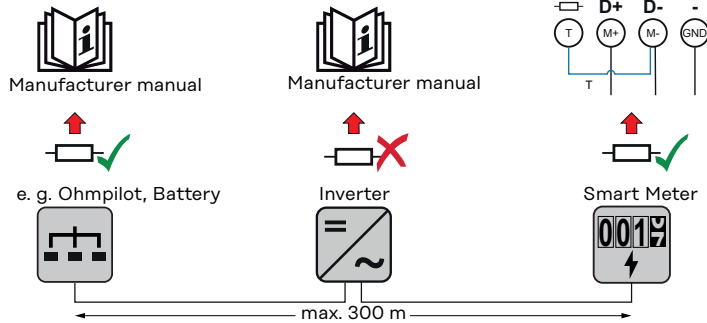

Close & Commissioning

7

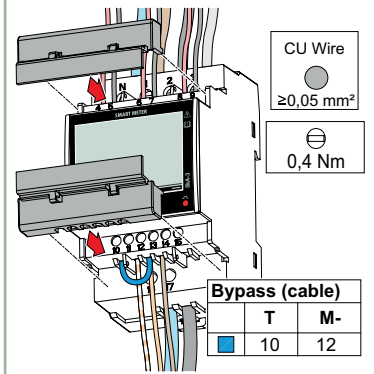

8

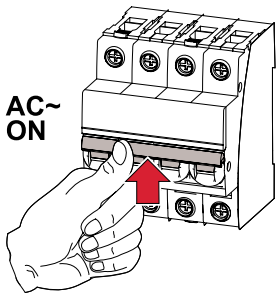

9

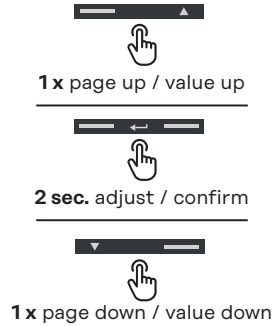

10

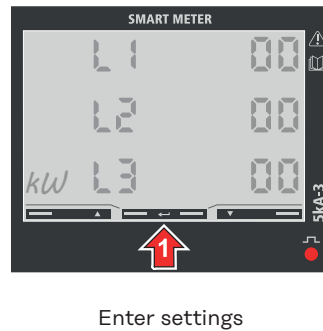

11



12

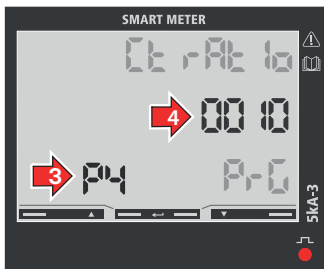

Transformation Ratio

13

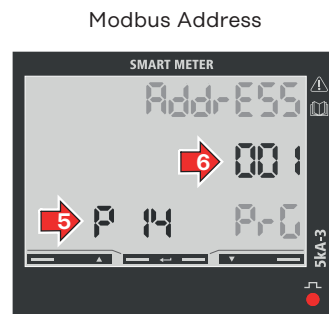

Factory default: 001

14

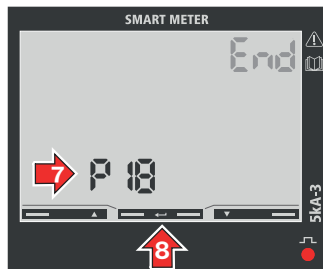

Exit

15

